

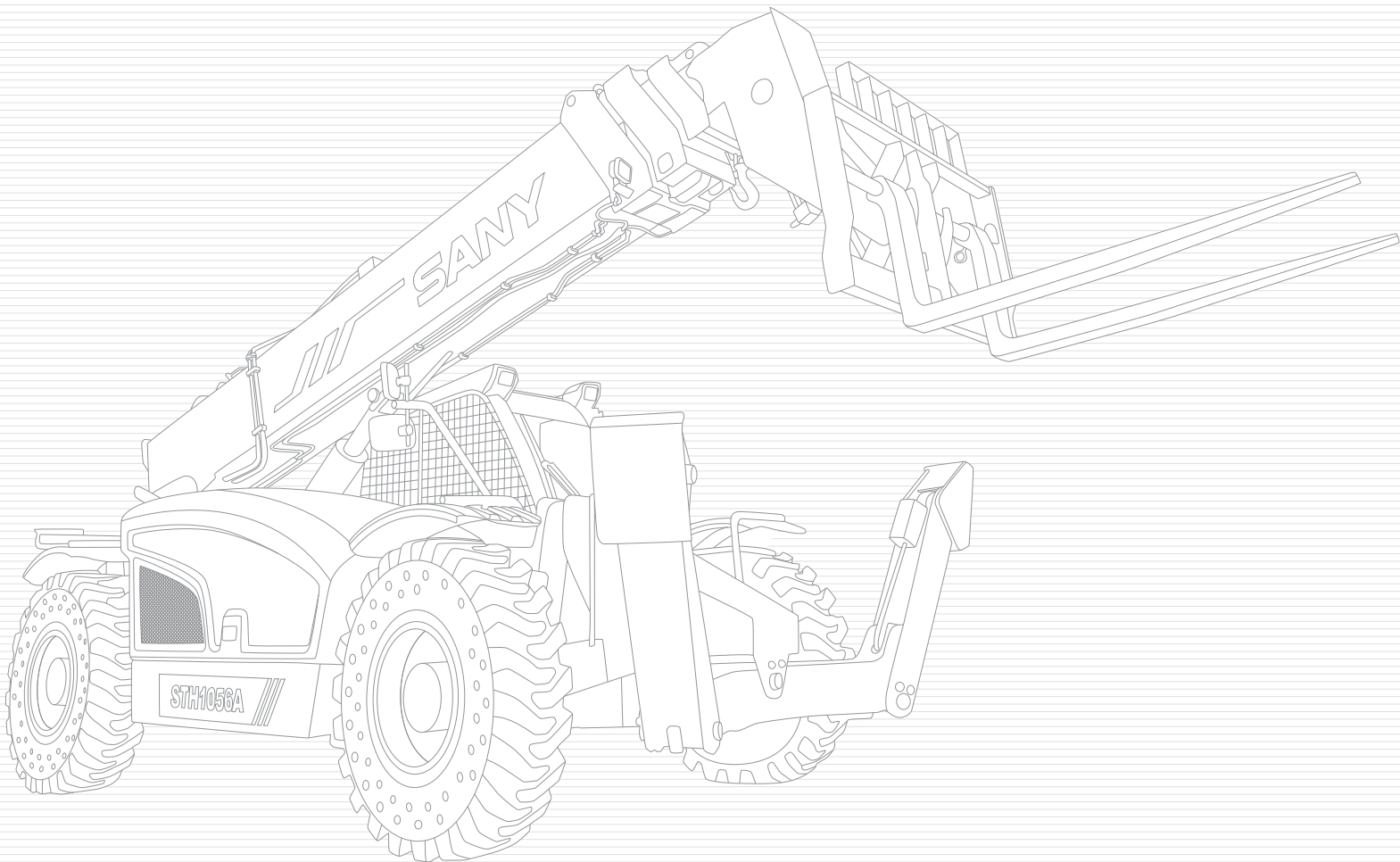

SANY NORTH AMERICAN TELEHANDLER



QUALITY CHANGES THE WORLD

► About SANY Marine

SANY Marine is one of the core business units of SANY Group, mainly engaged in container mobile equipment (Telehandler, empty container handler, electric terminal tractor), port equipment (quayside crane, yard crane, jib crane), logistics equipment (material handler, heavy-duty forklift, telehandler), bulk equipment (ship unloader, ship loader, stacker reclaimer), wind tower barrel and other products. We are committed to becoming a global port machinery leader and terminal automation solution provider.

Sany Marine adheres to the enterprise purpose of "to build a first-class enterprise, to foster first-class employees, and to make first-class contributions to society"; and the principle of "All for customers, all from innovation" business philosophy, always puts independent innovation in the first position of enterprise development, relying on a strong international brand influence and with a global marketing service network, products are exported to more than 100 countries around the world.

Sany Marine Zhuhai Industrial Park is located in Zhuhai Special Economic District, with a total land area of 2 million m² and a coastline of 1.5 km. Intelligent as the core, the introduction of cutting, machining, welding, painting and assembly robots and other intelligent equipment create an intelligent manufacturing lighthouse factory which leads the industry with the annual planned output value of 30 billion yuan.

Sany Marine has always adhered to the spirit of "quality to change the world" and continues to forge ahead in the field of port and logistics equipment.



QUALITY CHANGES THE WORLD

Production R&D System



Sany Marine R&D Building



Manufacture Technology

Advanced manufacturing technology is a reliable guarantee for creating excellent products. Sany Marine's 1# & 3# factories are small port machinery intelligent manufacturing factories, covering an area of 70,000 m², with 43 production robots and a welding automation rate of 80%. Factory 2#, 6#, 7#, and 8# are for large port machinery, covering 250,000 m² and equipped with 35 production robots to realize the automation of blanking, picking, machining, riveting and welding. The large port machinery assembly site covers 250,000 m². The largest 500T+900T jib cranes in the industry support the overall assembly of large port machinery.



Testing System

A complete R&D test system is the strong backing for excellent performance. Sany Marine has an R&D team of more than 500 people. It has established professional technical committees in machinery, electronic control, hydraulics, testing, etc., and has built multiple laboratories and test sites for simulation operation and maintenance, electrical and automation, and automated storage yards. More than 5% of revenue every year is spent on R&D, and key components must undergo more than 300,000 times fatigue tests.



Environmental Protection

Equipped with an eco-friendly engine that complies with the latest National IV standards and uses environmentally friendly paint to effectively reduce pollution. A full range of new energy products have achieved large-scale mass production and delivery.

Reliable Service

Reliable Service



Service Concept

- reply in 15 minutes
- arrive in 2 hours
- general fault solved in 1 day
- customer complaints resolved in 2 days
- general remaining problem solved in 7 days



Service Team

- 400 service engineers
- 60% obtained advanced skill level or above
- 300+ service vehicles
- 365 days*24h service



Service Outlets

- overseas office around globally
- 35 domestic service outlets
- service engineer standby in major cities



Accessory Storage

The four-in-one parts supply guarantee system of headquarters warehouse, regional central warehouse, provincial warehouse and municipal warehouse stores more than 100,000 kinds of spare parts

Customer APP

"Sany Customer APP" allows customers to monitor the operating status and reports of equipment in real time anywhere in the world, and provides value-added services such as online consultation, community communication, parts mall, one-click repair report, scheduled maintenance, and product knowledge learning.

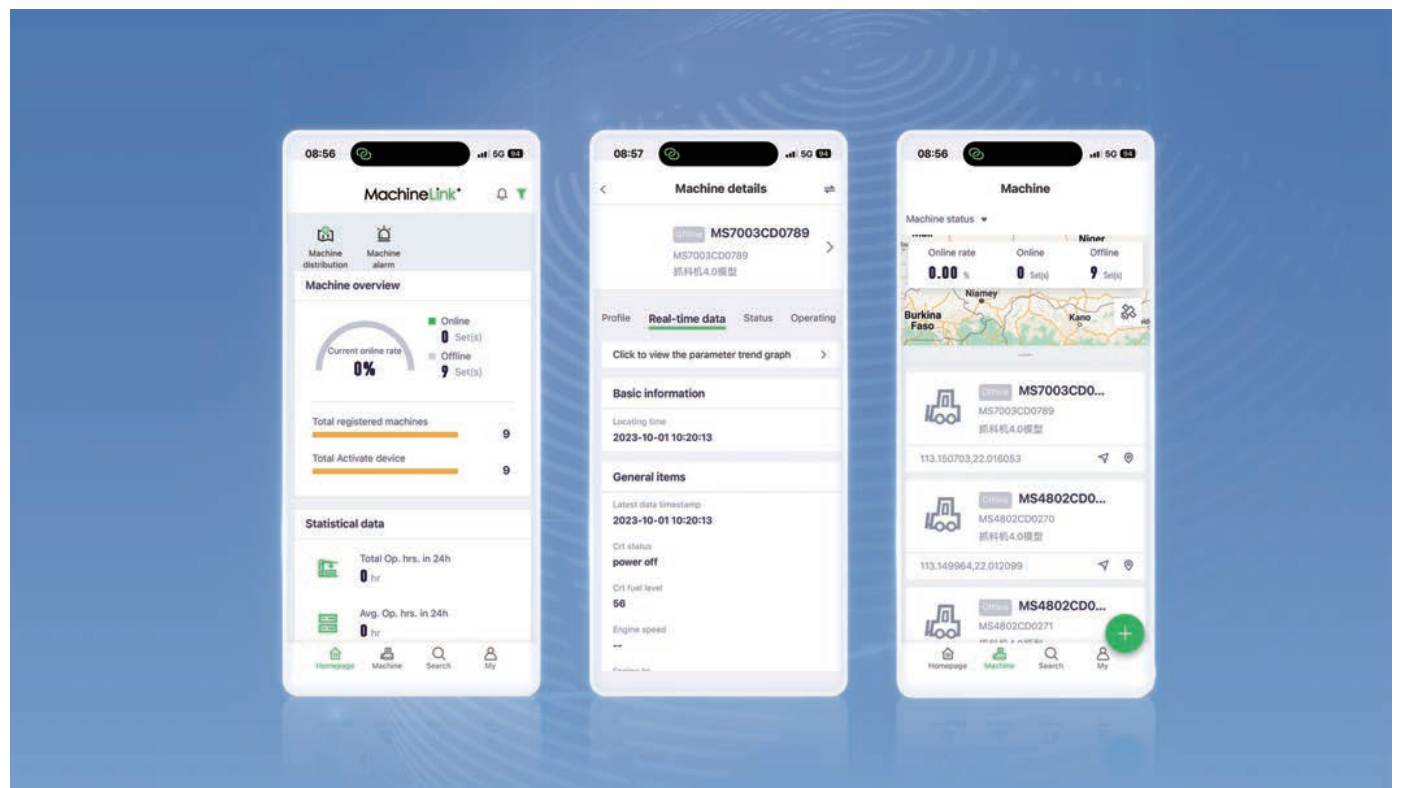

- ▶ SANY's telehandler portfolio has grown significantly over the years, and as we see a rise in demand for telehandlers over the next five years, SANY has been developing European and North American telehandler ranges.



North American Telehandler series

STH634 STH844 STH1056 STH1256

SANY Fuel Telehandler



1

Technology platform with advantages
Sany core technology based on years of technology, such as load matching energy-saving technology, roll-over protection technology.

2

Listen to American customer requirement
Listening to our customer requirement and understanding their desire for high reliability, high performance and low cost of usage and maintenance.

3

Large cab and Axle-mounted stabilizers
Large cab offers improved operator comfort and reduced fatigue
Axle-mounted stabilizers allow for smoother frame leveling when deployed.

4

High configuration for quality
Deutz engine, Dana transmission Dana drive axle, Parker hydraulic system
Simple maintenance with easy fluid level check and convenient access to maintenance items with side-mounted engine.

5

Pursuit of excellence Reliable and Durable
Structural components verified by fatigue test
Comprehensive test was carried out on the whole machine to ensure high reliability.

2024 Telehandler's Export Parameter Configuration

Group	Main Parameter				Key Parts Configuration						
					Standard Configuration					Optional Configuration	
	Max load capacity (t)	Max lifting height (mm)	load center (mm)	Min. turning radius (mm)	ENGINE	TRANSMISSION	DRIVE AXLE	MAIN VALVE	MAIN PUMP	Cabin	FORK
12k Series	5.44	17100	3490	4300	Cummins QSF3.8 T4F (97kW)	DANA Transmission Box T12000	DANA Axle 212H-Y/223	Parker Valve	Etlong	Closed cab (with air conditioning)	Forks: 48in, 60in, 72in Carriage: 48in, 60in, 72in Standard fast-fit carriage (Pipe clamp, hook), Rotating side-tilt carriage, Side-shift carriage, Man-platform, 1/15/2.5m³Bucket, Marble handler
					Cummins QSF3.8 T3(93kW)					Open cab	
					DEUTZ TCD3.6 Tier4F(90kW)	DANA 1120				Closed cab (with air conditioning)	
10k Series	4.54	17100	3490	4300	Cummins QSF3.8 T4F (97kW)	DANA Transmission Box T12000	DANA Axle 212H-Y/223	Parker Valve	Etlong	Closed cab (with air conditioning)	Forks: 48in, 60in, 72in Carriage: 48in, 60in, 72in Standard fast-fit carriage (Pipe clamp, hook), Rotating side-tilt carriage, Side-shift carriage, Man-platform, 1/15m³Bucket
					Cummins QSF3.8 T3(93kW)					Open cab	
					DEUTZ TCD3.6 Tier4F(90kW)	DANA 1120				Closed cab (with air conditioning)	
8k Series	3.63	13400	3420	4300	Cummins QSF3.8 T4 (55kW)	DANA Transmission Box T12000	DANA Axle 212H-Y/223	Parker Valve	Etlong	Closed cab (with air conditioning)	Forks: 48in, 60in, 72in Carriage: 48in, 60in, 72in Rotating side-tilt carriage, Side-shift carriage, 1.5m³Bucket
					Cummins QSR3.8 T3(74kW)					Open cab	
	3.6				DEUTZ TCD3.6 Tier4F(55kW)	DANA 1104				DANA Axle 212H-Y/212H-Y10151063	
6K Series	2.722	103545	3140	4200	DEUTZ TD 2.9	DANA Transmission Box T12000	DANA Axle 212	Parker Valve	Casappa	Open cab	Forks: 48in, 60in Carriage: 48in, 60in
										Closed cab (with air conditioning)	

▶ Key Features



Key Features



Reliability

Strict test on rough terrain
Full-case simulation + test verification



Operability

Great operating visibility
and reverse radar display



Easy maintenance

Hydraulic Manifold
Automatic fault diagnosis
Ground maintenance
Powertrain layout
Attachment change



Intelligent

Real-time display and monitoring of
machine parameters

Reliability

Strict test on rough terrain

Rough terrain test

- 300h of road test, the reliability of the chassis has been fully verified. test vehicle in full load operation.

Boom fatigue test platform

- Load telescopic boom by 40000 times test. Each loop with full load based on the load chart. Rigorous testing to ensure the reliability of boom strength.

Full-case simulation + test verification

- Simulation and testing of the entire vehicle through the creation of an Adams-based vehicle dynamics model and digital prototype simulation on a virtual test track.
- The strength of the whole machine structure is analyzed by FEM.

Operability

Great operating visibility and reverse radar display

Reversing aid system

- Wide-angle rear camera gives unobstructed view behind the machine.

Operation

- The Load feedback hydraulic system, greatly reduce heating, provides excellent control precision performance to improve operation.

Visibility

- The boom, chassis is designed for maximum visibility, The whole machine has a good all-round visibility to the front, rear and sides.

Easy maintenance

Hydraulic Manifold

- Large space for the Manifold maintenance.

Automatic fault diagnosis

- For real-time display all can identify the fault code, convenient for trouble shooting.

Ground maintenance

- Oil feet, air filters, oil-water separator, oil filter, such as daily maintenance projects can be done on the ground.

Powertrain layout

- Good accessible, all kinds of filter and the replacement of the oil is convenient, troubleshooting and maintenance space is enough.

Attachment change

- Apparels to replace all kinds of fittings by quick change coupling easy replacement.

Intelligent

Real-time display and monitoring of machine parameters

- Integrated screen to show all operation information.
- LLMC (longitudinal load moment control) with 5% accuracy. Weighing system with real-time display of boom length, boom angle, object weight, etc.
- Intelligent protection system; Complete power system monitoring protection system, for the water temperature, the oil temperature is high, the pressure.

▶ Attachments

▶ 60in carriage

(Optional 48in/60in/72in Forks)

▪ Adaptive: 8K/10K/12K

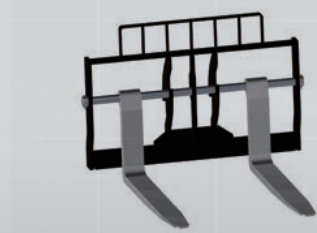

▶ 72in carriage

(Optional 48in/60in/72in Forks)

▪ Adaptive: 8K/10K/12K



▶ Pipe clamp

▪ Adaptive: 10K/12K



▶ 1.5m³ Bucket

▪ Adaptive: 8K/10K/12K



▶ Rotating side-tilt carriage

(Optional 48in/60in/72in Forks)

▪ Adaptive: 8K/10K/12K

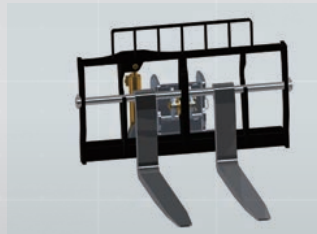

▶ Side-shift carriage

(Optional 48in/60in/72in Forks)

▪ Adaptive: 8K/10K/12K

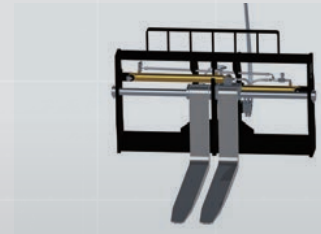

▶ Man-platform

(2300*800 Man platform)

▪ Adaptive: 10K/12K



▶ Marble handler

(1.5T Slabstone carrier)

▪ Adaptive: 12K

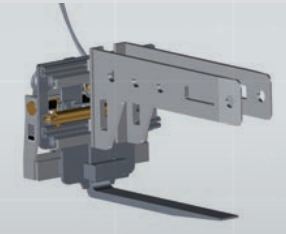

▶ Standard fast-fit fork

(60in Forks)

▪ Adaptive: 10K/12K

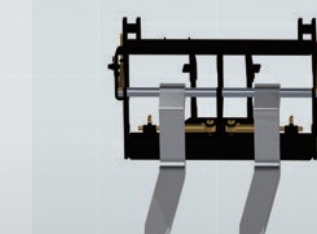

▶ Bucket

(1m³)

▪ Adaptive: 10K/12K

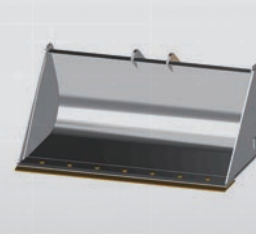

▶ 48in carriage

(Optional 48in/60in/72in Forks)

▪ Adaptive: 8K/10K/12K



▶ 48in carriage

(Optional 48in/60in Forks)

▪ Adaptive: 6K



▶ Man-platform

(1000*640)

▪ Adaptive: 10K/12K

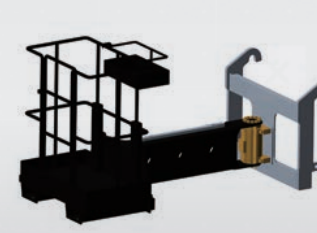

▶ Hook

▪ Adaptive: 10K/12K

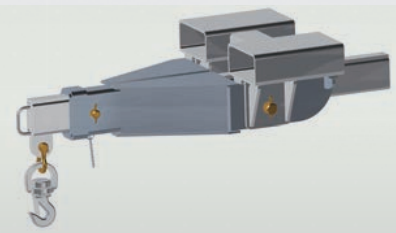

▶ 60in carriage

(Optional 48in/60in Forks)

▪ Adaptive: 6K



▶ 2.5m³ Bucket

▪ Adaptive: 12K

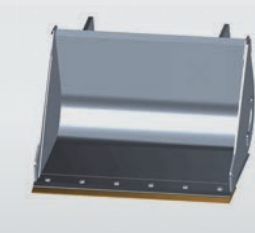

► Construction Cases



MONTREAL (Head office)
100A, Hymus Blvd.
Pointe-Claire (Québec) H9R 1E4
Phone: 514 694-4223
Toll free: 1 866 421-4223
info@elevex.ca

QUEBEC
1279, Paul-Émile Giroux St. Suite
200 Québec (Québec) G1C 0K9
SAGUENAY
2305, Alexis-Le-Trotteur
St. Jonquière (Québec) G7X 9H8

